

BROCAS e CHANFRADORES COM PASTILHAS INTERCAMBIÁVEIS

Rev. 1



YNOWA
MADE IN BRAZIL

COM INSERTO INTERCAMBIÁVEL

3xD

diâmetros		Pastilhas (utilizadas)
de	até	
12,7	17	LCMX 02 02 04 P
		LCMX 02 02 04 C
17,5	20	LCMX 03 03 08
21	25	LCMX 04 03 08
26	30	WCMX 05 03 08
31	41	WCMX 06 T3 08
42	-	WCMX 08 04 12

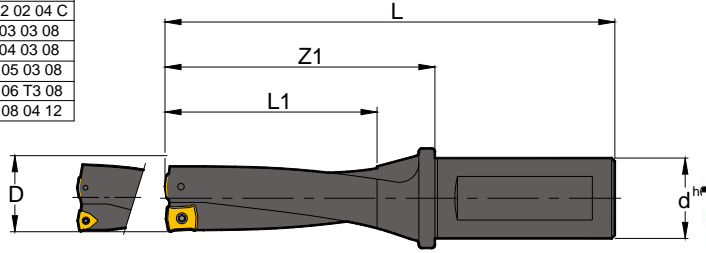

- Diâmetros de Usinagem - Ø12.7 - Ø50mm
- Z1 menor ou maior que o indicado, somente sob consulta
- Profundidade de corte - 3xD

L1= profundidade de programação

Dimensões

D	d	L	L1	Z1	CÓDIGO	Pastilha	Parafuso	Chave
12,7		104	41	54	5320 60 02-127	 LCMX 02 02 04 P LCMX 02 02 04 C P - periférico C - central	30160000227	40210000085
13		105	42	55	5320 60 02-013			
13,5		106	43	56	5320 60 02-135			
14		108	45	58	5320 60 02-014			
14,5	20	110	46	60	5320 60 02-145			
15		112	48	62	5320 60 02-015			
15,5		114	50	64	5320 60 02-155			
16		116	51	66	5320 60 02-016			
16,5		118	53	68	5320 60 02-165			
17		119	54	69	5320 60 02-017			
17,5		128	56	72	5325 60 03-175	LCMX 03 03 08	30160000227	40210000085
18		129	57	73	5325 60 03-018			
18,5	25	131	59	75	5325 60 03-185			
19		132	60	76	5325 60 03-019			
20		137	64	81	5325 60 03-020			
21		140	66	84	5325 60 04-021	LCMX 04 03 08	30160000224	40210000085
22		143	69	87	5325 60 04-022			
23	25	147	72	91	5325 60 04-023			
24		151	76	95	5325 60 04-024			
25		155	79	99	5325 60 04-025			
26		162	81	102	5332 60 05-026	WCMX 05 03 08	30160000234	40210000086
26,5		162	81	102	5332 60 05-265			
27	32	165	84	105	5332 60 05-027			
28		169	87	109	5332 60 05-028			
29		172	90	112	5332 60 05-029			
30		177	94	117	5332 60 05-030			
31		191	97	121	5340 60 06-031	 WCMX 06 T3 08	30160000231	40210000087
32		194	100	124	5340 60 06-032			
33		198	103	128	5340 60 06-033			
34		201	106	131	5340 60 06-034			
34,5		201	106	131	5340 60 06-345			
35	40	205	109	135	5340 60 06-035			
36		209	112	139	5340 60 06-036			
37		212	115	142	5340 60 06-037			
38		216	118	146	5340 60 06-038			
39		219	121	149	5340 60 06-039			
40		223	124	153	5340 60 06-040	WCMX 08 04 12	30160000237	40210000089
41		227	127	157	5340 60 06-041			
50	40	245	160	175	5340 60 08-050			

Exemplo para pedido: 10 pçs - **5320 60 02-127**

Obs.: Para utilização de outros tipos de pastilhas - sob consulta

Observação:

1) Sistema com refrigeração interna



Nota:

Ao furar peças rotativas, um disco de metal é produzido no final do furo. Precauções devem ser tomadas para evitar acidentes.

Chanfrador

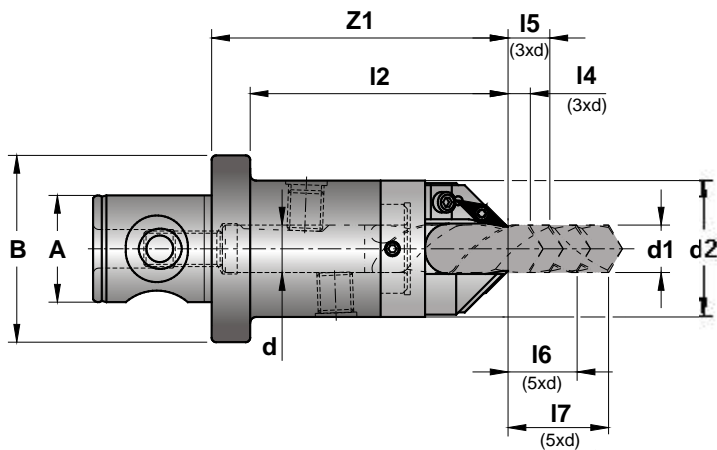

Dimensões da Broca

A x B	Dimensões da Adaptação				Dimensões da Broca					Ref.	CÓDIGO
	d	d1	d2	I2	Z1	I4	I5	I6	I7		
28 x 50	6	5 a 6	35	65	76	-	-	8	15	130 37 06	10016000007
	8	6.1 a 8	35	65	76	4	16	16	28	130 37 08	10016000006
	10	8.1 a 10	42	79	90	4	18	18	32	130 37 10	10016000005
	12	10.1 a 12	42	84	95	8	24	24	40	130 37 12	10016000004
	14	12.1 a 14	46	84	95	16	30	33	47	130 37 14	10016000003
36 x 63	16	14.1 a 16	46	87	100	14	34	32	52	140 37 16	10016000002
	18	16.1 a 18	50	95	108	14	37	34	57	140 37 18	10016000001
	20	18.1 a 20	58	95	108	32	50	54	72	140 37 20	10016000008

Exemplo para pedido 01 pç - 10016000007

COMPONENTES

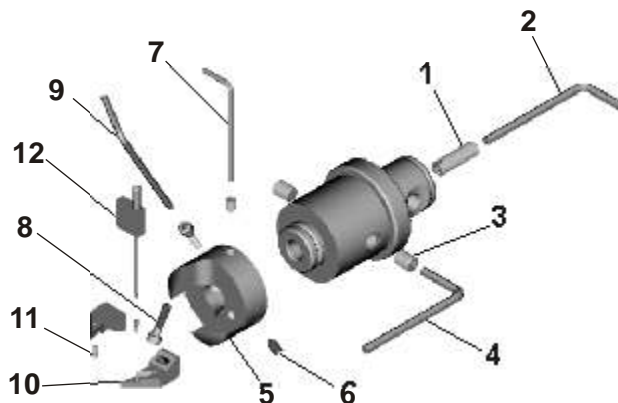

Códigos dos componentes

Item	10016000007 ref. 130 37 06	10016000006 ref. 130 37 08	10016000005 ref. 130 37 10	10016000004 ref. 130 37 12	10016000003 ref. 130 37 14	10016000002 ref. 140 37 16	10016000001 ref. 140 37 18	10016000008 ref. 140 37 20
1 Parafuso	30160000347	30160000345	30160000344	30160000343	30160000343	30160000323	30160000323	30160000348
2 Chave	40210000025	40210000026	40210000022	40210000024	40210000024	40210000027	40210000027	40210000028
3 Parafuso	30160000057	30160000057	30160000058	30160000045	30160000046	30160000046	30160000272	30160000048
4 Chave	40210000026	40210000026	40210000022	40210000024	40210000024	40210000024	40210000095	40210000028
5 Porta Cápsula	34140000108	34140000108	30146000017	30146000017	30146000016	30146000016	30146000015	30146000036
6 Parafuso	30160000145	30160000145	30160000145	30160000145	30160000145	30160000145	30160000145	30160000145
7 Chave	40210000025	40210000025	40210000025	40210000025	40210000025	40210000025	40210000025	40210000025
8 Parafuso	30160000436	30160000436	30160000436	30160000436	30160000436	30160000436	30160000313	30160000313
9 Chave	40210000026	40210000026	40210000026	40210000026	40210000026	40210000026	40210000026	40210000026
10 Cápsula	10015000001	10015000001	10015000001	10015000001	10015000001	10015000001	10015000001	10015000001
11 Parafuso	30160000225	30160000225	30160000225	30160000225	30160000225	30160000225	30160000225	30160000225
12 Chave	40210000085	40210000085	40210000085	40210000085	40210000085	40210000085	40210000085	40210000085

Observações:

1) Z1 menor ou maior que o indicado, somente sob consulta

2) Sistema com refrigeração interna 

Observações:

- Broca não fornecida

- Pedir insertos separadamente:

Para alumínio - VPGX 1102 FR 45° J - F 004

Para aço - VPGY 1102 FR 45° - Z 001

Para fofo - VPGW 1102 FR 45° - F 004

Tabelas para solicitação de brocas especiais

Preencher com as devidas informações e nos enviar por e-mail ou fax.

diâmetros		Pastilhas (utilizadas)
de	até	
12,7	17	LCMX 02 02 04 P LCMX 02 02 04 C
17,5	20	LCMX 03 03 08
21	25	LCMX 04 03 08
26	30	WCMX 05 03 08
31	41	WCMX 06 T3 08
42	58	WCMX 08 04 12

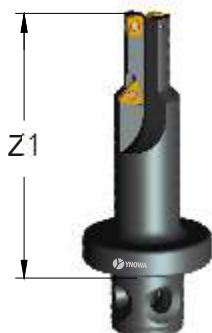

Ferramenta especial para furar e chanfrar

	L1	L2	A	D1	Z1	Pastilha broca	Pastilha chanfro
1							
2							
3							
+							

Tipo da adaptação Modular / Din 1835 / Weldon / Outros.

TIPO 1

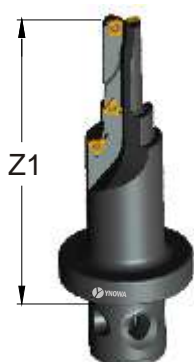
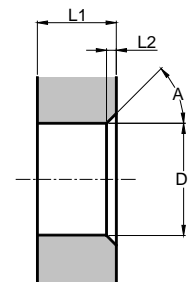

Ferramenta especial para furar, chanfrar e facear

	L1	L2	L3	A	D1	D2	Z1	Pastilha broca	Pastilha chanfro
1									
2									
3									
+									

Tipo da adaptação Modular / Din 1835 / Weldon / Outros.

TIPO 2

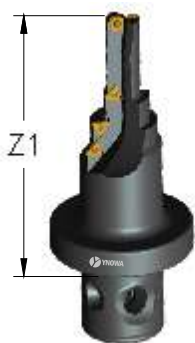
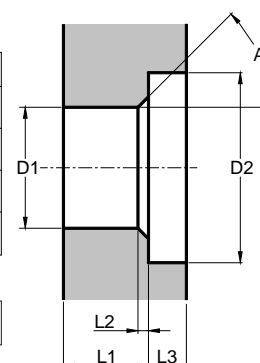

Ferramenta especial para furar, chanfrar, facear e chanfrar

	L1	L2	L3	L4	A	B	D1	D2	Z1	Pastilha broca	Pastilha chanfro
1											
2											
3											
+											

Tipo da adaptação Modular / Din 1835 / Weldon / Outros.

TIPO 3

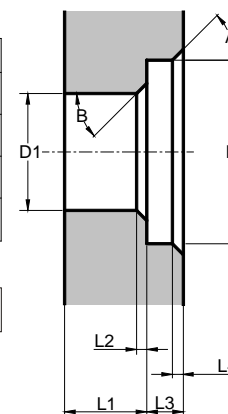

Ferramenta especial para furar, calibrar furo e chanfrar

	L1	L2	A	D1	D2	Z1	Pastilha broca	Pastilha chanfro	Cápsula
1									
2									
3									
4									

Tipo da adaptação Modular / Din 1835 / Weldon / Outros.

TIPO 4

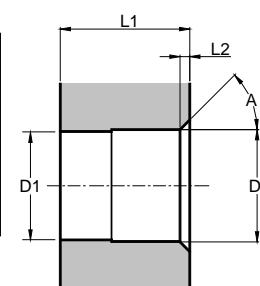

Ferramentas com refrigeração interna.

Tabelas para solicitação de rebaixadores especiais

Preencher com as devidas informações e nos enviar por e-mail ou fax.

TIPO 5

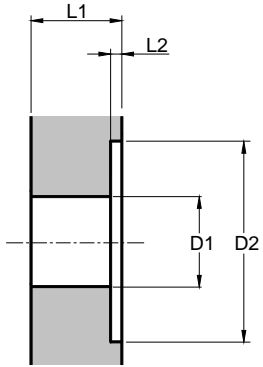

Ferramenta especial para rebaixar

	L1	L2	D1	D2	Z1	Pastilha face
1						
2						
3						
4						

Tipo da adaptação Modular / Din 1835 / Weldon / Outros.

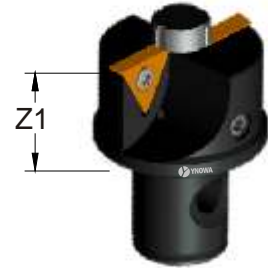

TIPO 6

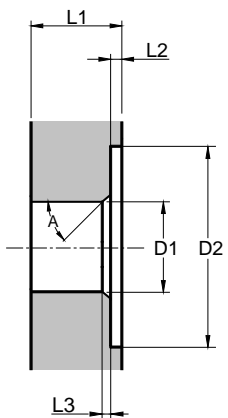

Ferramenta especial para rebaixar e chanfrar

	L1	L2	L3	A	D1	D2	Z1
1							
2							
3							
4							

Tipo da adaptação Modular / Din 1835 / Weldon / Outros.



Ferramentas com refrigeração interna.

ISO 9001

BUREAU VERITAS
Certification



YNOWA FERRAMENTAS LTDA
RUA CLÁUDIA SOARES, Nº 153 - BAIRRO PORTAL DO SOL
SÃO JOSÉ DOS PINHAIS - PARANÁ - CEP 83020-790
Fone: (41)3595-4545 - Fax: (41)3595-4546
CNPJ: 08.089.188/0001-06
INSC. EST.: 90.375.281-50
E-mail: ynowa@ynowa.com.br
Site: www.ynowa.com.br

Representante: _____